



WARNING:

INSTALL PRODUCT IN ACCORDANCE WITH LOCAL AND NATIONAL ELECTRICAL CODES BY A QUALIFIED ELECTRICIAN.



WARNING:

FAILURE TO COMPLY WITH THE INSTALLATION INSTRUCTIONS MAY RESULT IN DEATH OR SERIOUS INJURY.



WARNING:

READ ALL SAFETY INSTRUCTIONS INCLUDED WITH LUMINAIRE BEFORE INSTALLING LUMINAIRE. SAVE INSTRUCTIONS FOR FUTURE USE.

CAUTION:

THIS IS AN ELECTRONIC DEVICE. CARE MUST BE TAKEN DURING STORAGE AND HANDLING. STORE IN A CLEAN, COOL AND DRY LOCATION. ELECTROSTATIC DISCHARGE (ESD) CAN HARM THIS PRODUCT. AVOID STATIC DISCHARGE WHILE HANDLING THIS PRODUCT.

CAUTION:

INTER-LUX IS NOT RESPONSIBLE FOR THE STRUCTURAL INTEGRITY OF THE BUILDING TO SUPPORT THE LUMINAIRE. ADDITIONAL BACKING MAY BE REQUIRED.

Mounting Dimensions

Top View

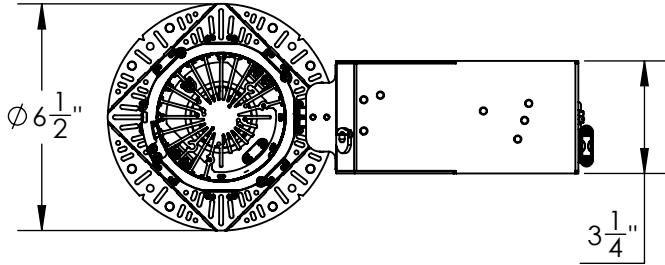

Side View

minimum void depth 9"

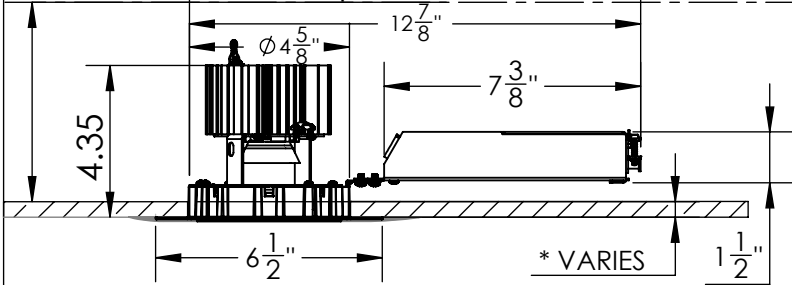

* Minimum and Maximum thickness of ceiling are 1/16" and 1", respectively.

Isometric View

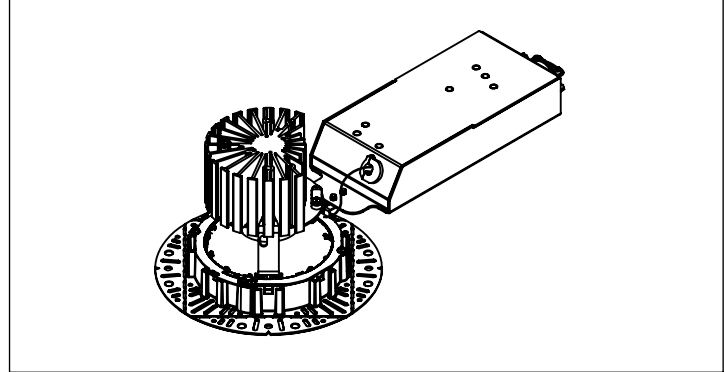
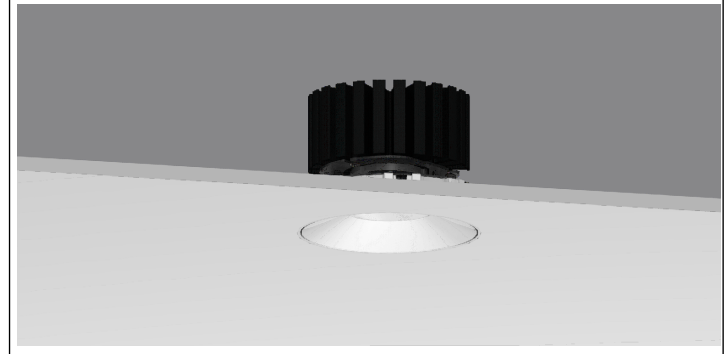
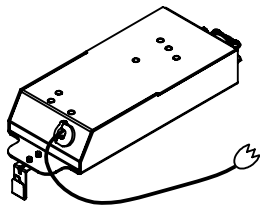

Photo Rendering



Package Includes:

Driver Box (A)



Housing (B)

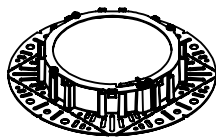

Light Engine (C)

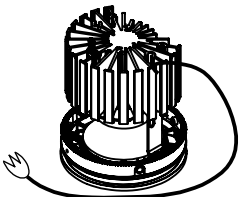

Regressed Cover (D)

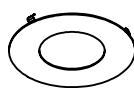

or

Cone Cover (D)

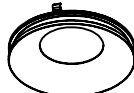

Items needed (supplied by others)

Phillips Head Screwdriver

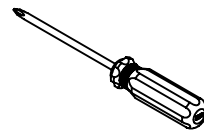

Drywall Screws

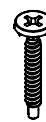

Wire Strippers

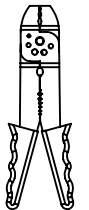

Wire Connector



Trowel and Plaster



Hole Saw 4-3/4"

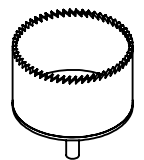

WARNING:
INSTALL PRODUCT IN ACCORDANCE WITH LOCAL AND NATIONAL ELECTRICAL CODES BY A QUALIFIED ELECTRICIAN.

WARNING:
FAILURE TO COMPLY WITH THE INSTALLATION INSTRUCTIONS MAY RESULT IN DEATH OR SERIOUS INJURY.

WARNING:
READ ALL SAFETY INSTRUCTIONS INCLUDED WITH LUMINAIRE BEFORE INSTALLING LUMINAIRE. SAVE INSTRUCTIONS FOR FUTURE USE.

CAUTION:
THIS IS AN ELECTRONIC DEVICE. CARE MUST BE TAKEN DURING STORAGE AND HANDLING. STORE IN A CLEAN, COOL AND DRY LOCATION. ELECTROSTATIC DISCHARGE (ESD) CAN HARM THIS PRODUCT. AVOID STATIC DISCHARGE WHILE HANDLING THIS PRODUCT.

CAUTION:
INTER-LUX IS NOT RESPONSIBLE FOR THE STRUCTURAL INTEGRITY OF THE BUILDING TO SUPPORT THE LUMINAIRE. ADDITIONAL BACKING MAY BE REQUIRED.

INSTALLATION INSTRUCTIONS

LOCATE AND REVIEW ANY CONSTRUCTION PLANS AND INTER-LUX RECORD DRAWINGS FOR ALL FIXTURE RUNS. IT IS RECOMMENDED TO LOCATE AND LAY OUT ALL COMPONENTS FOR EACH FIXTURE "RUN". A FIXTURE RUN TYPICALLY CONSISTS OF JOINERS, LENGTHS OF HOUSING, AND ENDCAPS. BE SURE TO IDENTIFY ALL CORRECT LENGTHS FOR EACH FIXTURE RUN.

Step 1; Prepare Ceiling: Turn off Power Before Installation. Cut a hole in the ceiling and clear insulation as shown below. The 12" space is made to accommodate the Driver (A) and 3" of clearance.

Bottom View

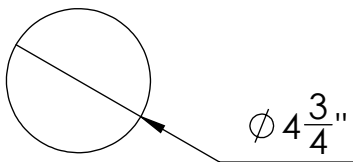

Side View

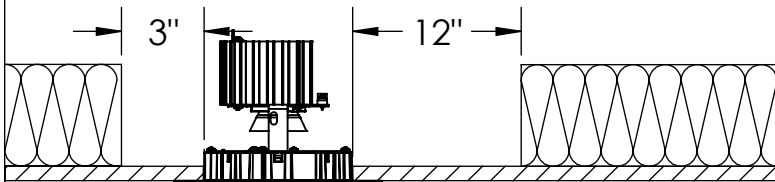

Step 2; Installation of Housing: Firmly insert the Housing (B) in the ceiling hole. Then, fasten the Housing (B) using at least 4 drywall screws as shown below. Keep Styrofoam Shield inside Housing (B).

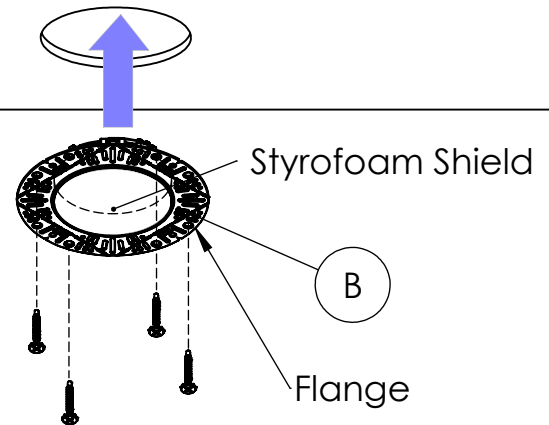

Step 3; Plastering: Apply plaster over the flange of housing.

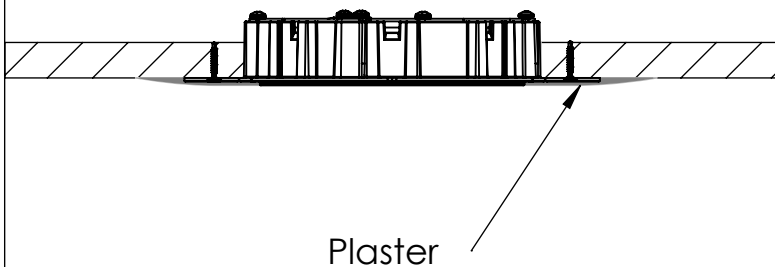

Step 4; Wiring: Remove styrofoam shield from Housing (B). Then, pull AC Power cables through the Housing (B), and make connection to the Driver (A).

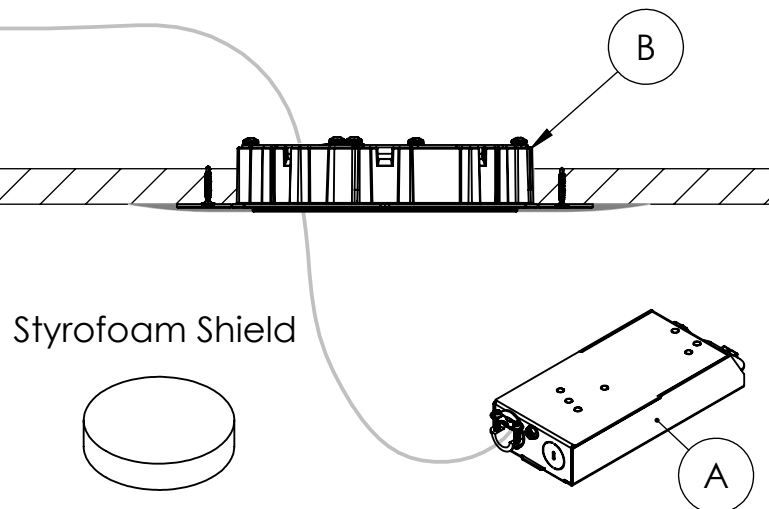

WARNING:
INSTALL PRODUCT IN ACCORDANCE WITH LOCAL AND NATIONAL ELECTRICAL CODES BY A QUALIFIED ELECTRICIAN.

WARNING:
FAILURE TO COMPLY WITH THE INSTALLATION INSTRUCTIONS MAY RESULT IN DEATH OR SERIOUS INJURY.

WARNING:
READ ALL SAFETY INSTRUCTIONS INCLUDED WITH LUMINAIRE BEFORE INSTALLING LUMINAIRE. SAVE INSTRUCTIONS FOR FUTURE USE.

CAUTION:
THIS IS AN ELECTRONIC DEVICE. CARE MUST BE TAKEN DURING STORAGE AND HANDLING. STORE IN A CLEAN, COOL AND DRY LOCATION. ELECTROSTATIC DISCHARGE (ESD) CAN HARM THIS PRODUCT. AVOID STATIC DISCHARGE WHILE HANDLING THIS PRODUCT.

CAUTION:
INTER-LUX IS NOT RESPONSIBLE FOR THE STRUCTURAL INTEGRITY OF THE BUILDING TO SUPPORT THE LUMINAIRE. ADDITIONAL BACKING MAY BE REQUIRED.

INSTALLATION INSTRUCTIONS

LOCATE AND REVIEW ANY CONSTRUCTION PLANS AND INTER-LUX RECORD DRAWINGS FOR ALL FIXTURE RUNS. IT IS RECOMMENDED TO LOCATE AND LAY OUT ALL COMPONENTS FOR EACH FIXTURE "RUN". A FIXTURE RUN TYPICALLY CONSISTS OF JOINERS, LENGTHS OF HOUSING, AND ENDCAPS. BE SURE TO IDENTIFY ALL CORRECT LENGTHS FOR EACH FIXTURE RUN.

Step 5; Installation of Driver Box: Push the Driver Box (A) up through the Housing (B). Insert the tab protruding from the Driver (A) into one of the slots located on the Housing (B).

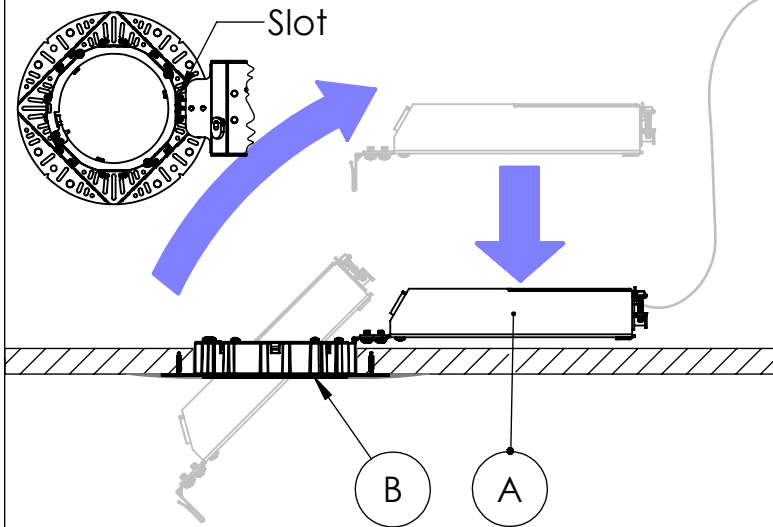

Step 6; Installation of Safety Cable: Attach the Safety Cable to the Light Engine (C). Then, make the electrical connection between the Driver (A) and the Light Engine (C).

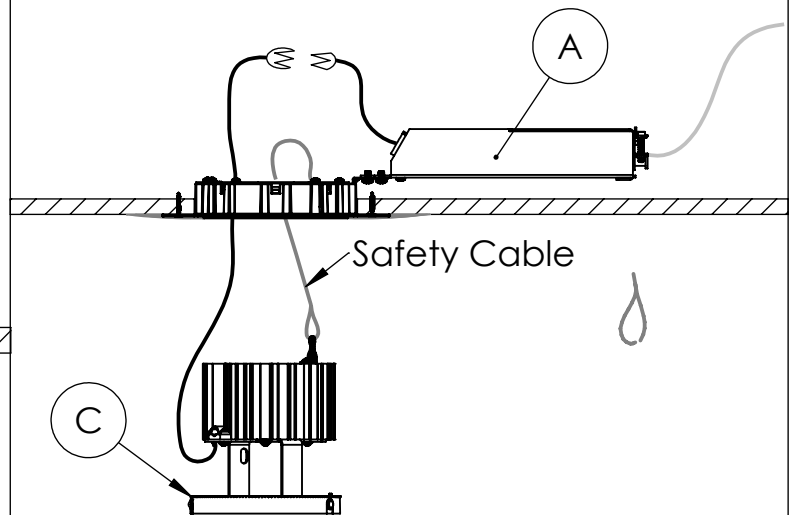

Step 7; Assembly of Diffuser: Align legs of Diffuser (D) with holes on Light Engine (C), then insert the Diffuser (D) into Light Engine (C) until it locks into place.

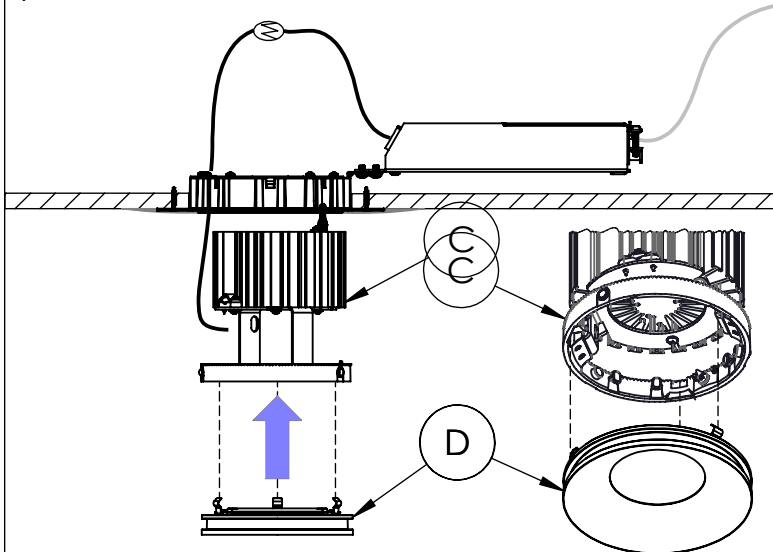

Step 8; Final Assembly: Push the Light Engine (C) up into ceiling until it locks into the Housing (B). Make sure pin of the Housing (B) enters between the fins of Light Engine (C). Finally, power and test the Luminaire for proper operation.

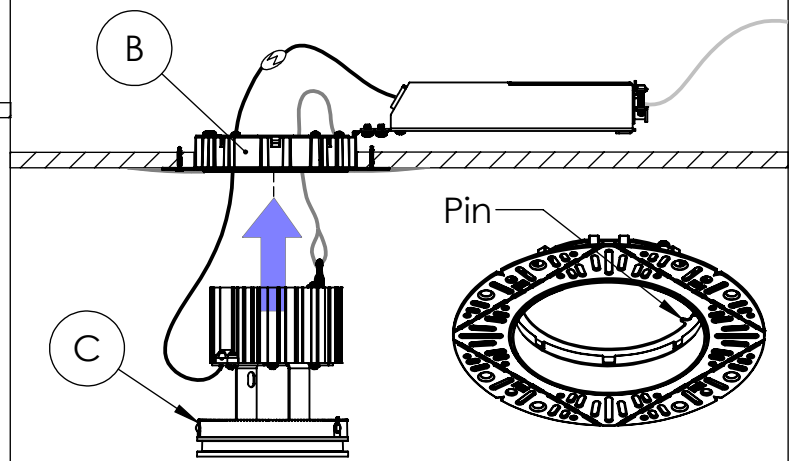

WARNING:
INSTALL PRODUCT IN ACCORDANCE WITH LOCAL AND NATIONAL ELECTRICAL CODES BY A QUALIFIED ELECTRICIAN.

WARNING:
FAILURE TO COMPLY WITH THE INSTALLATION INSTRUCTIONS MAY RESULT IN DEATH OR SERIOUS INJURY.

WARNING:
READ ALL SAFETY INSTRUCTIONS INCLUDED WITH LUMINAIRE BEFORE INSTALLING LUMINAIRE. SAVE INSTRUCTIONS FOR FUTURE USE.

CAUTION:
THIS IS AN ELECTRONIC DEVICE. CARE MUST BE TAKEN DURING STORAGE AND HANDLING. STORE IN A CLEAN, COOL AND DRY LOCATION. ELECTROSTATIC DISCHARGE (ESD) CAN HARM THIS PRODUCT. AVOID STATIC DISCHARGE WHILE HANDLING THIS PRODUCT.

CAUTION:
INTER-LUX IS NOT RESPONSIBLE FOR THE STRUCTURAL INTEGRITY OF THE BUILDING TO SUPPORT THE LUMINAIRE. ADDITIONAL BACKING MAY BE REQUIRED.

Wiring Key

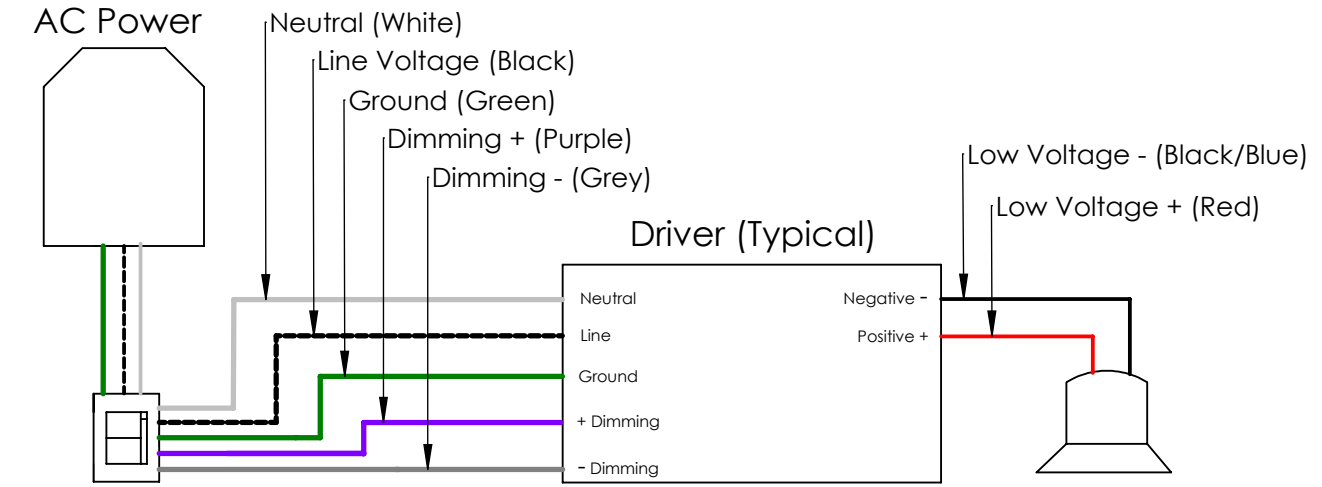

Red	Blue/Black	Green	Black	White	Purple	Grey
Positive	Negative	Ground	Line	Neutral	Dimming +	Dimming -

Maximum wire distance and voltage drop to be calculated by installer.

Driver Wiring Diagrams

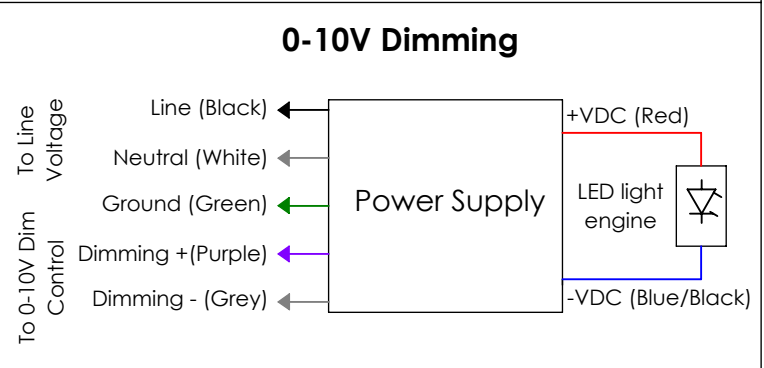
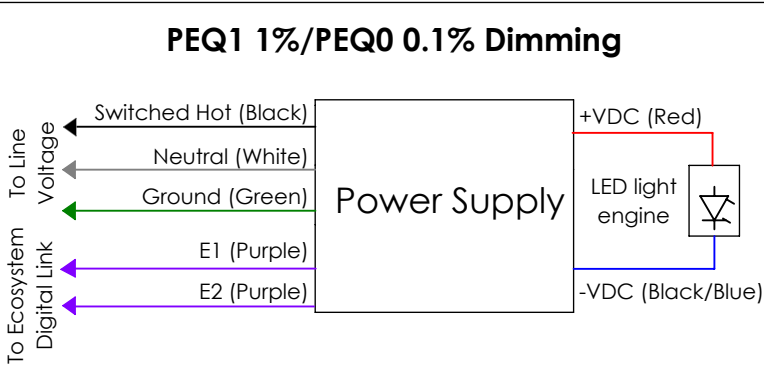
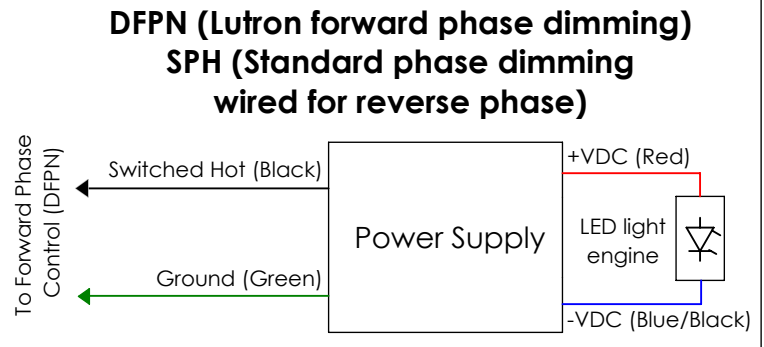
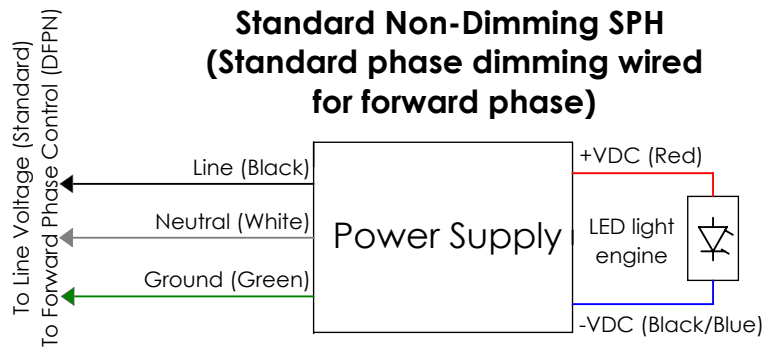

NOTE: ALL SHOWN DRIVERS ARE INTER-LUX PROVIDED. FOR NON INTER-LUX PROVIDED DRIVERS PLEASE REFER TO DRIVER MANUFACTURERS. THE USE OF NON INTER-LUX PROVIDED DRIVERS VOIDS PRODUCT WARRANTY.