

100 Square Ceiling / Floor Wash Specifications



Recessed Plaster Trim



Recessed Bezel Trim

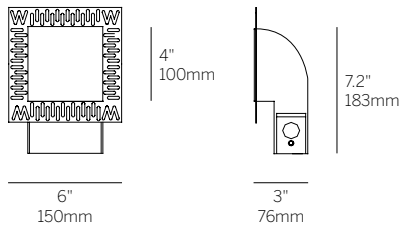

Recessed Plaster Trim (RPT)

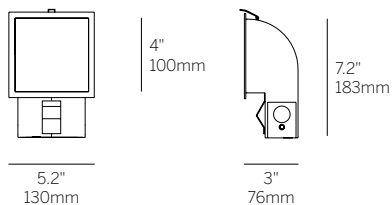

Recessed Bezel Trim (RBT)

Ordering Information

Model	Fixation	Power ¹	CRI/CCT ²	Driver ³	Finish
WG-100SCFW	RPT RBT	H	827 830 835 840 927 930 935 940	X S D010 PEQ1 PEQ0 DFPN	W (std)

Luminaire

- Bezel Trim or Plaster Trim 4" ceiling or floor washer for drywall.
- Installation from room side of the wall for remodel or new construction.
- 'Easy click' tool free installation of diecast aluminum lamp insert module.
- Heavy gauge steel trim housing.

Power

- H = High Power, 6.4W @ 700mA

CRI/CCT¹

LED Citizen, 80+ CRI

- CB-827 = 2700K, (565lm)
- CB-830 = 3000K, (579lm)
- CB-835 = 3500K, (598lm)
- CB-840 = 4000K, (608lm)
- For 90+ CRI, specify CB-927, CB-930, etc. Approximately 15% less lumens than 80+ CRI.
- For 95+ CRI, specify CB-F927, CB-F930, etc. Approximately 30% less lumens than 80+ CRI.

Power Supply (remote only)¹

- X = No driver
- S = Standard non-dim driver, 120-277V
- D010 = EldoLED, 1%, 0-10V dimming, 120-277V
- PEQ1 = Lutron Hi-lume 1% EcoSystem, 120-277V
- PEQ0 = Lutron Hi-lume Premier 0.1% EcoSystem, 120-277V
- DFPN = Lutron Forward Phase 1% 120VAC

Finish

- W = White, RAL9010 (standard)

Emergency

- Emergency LED driver available, order separately (remote)

¹ Other lumen packages available, consult factory.

² See IES files for delivered lumens.

³ Wattage shown does not include power supplies/drivers. System wattage adds 10-20%.

⁴ See power supply page for details.

100 Square Ceiling / Floor Wash

Dimensions

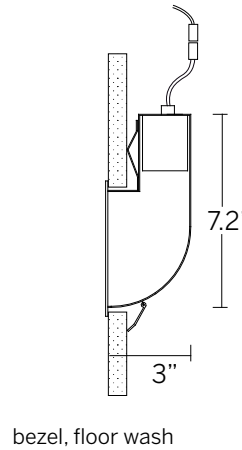
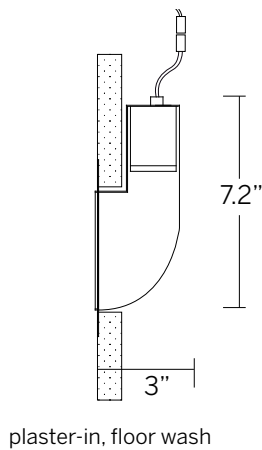
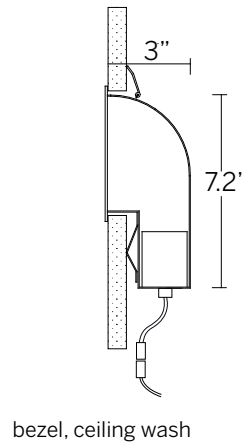
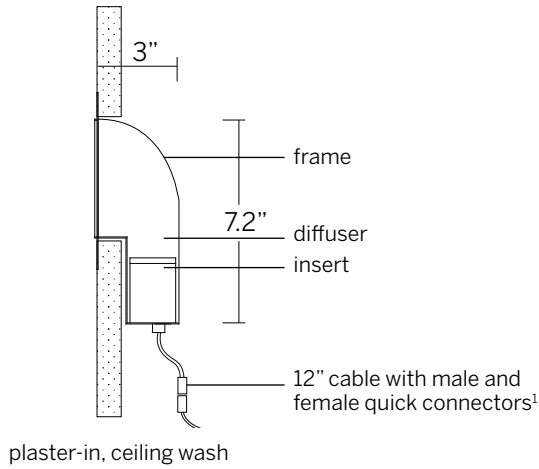

cut-out dimensions 4 5/8" x 4 5/8"

¹Connectors included. Class II low voltage wire supplied by others. See power supply page for details.

Plaster-in instructions

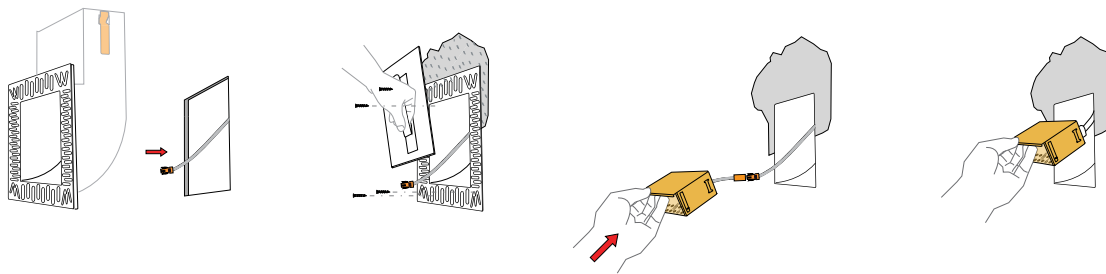

Bezel instructions

