

Lamp Removal (Flush Fit Diffuser)

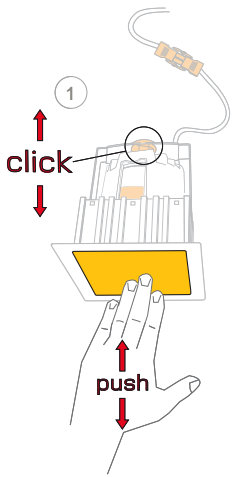

Lamp Removal (Flush Fit Diffuser)

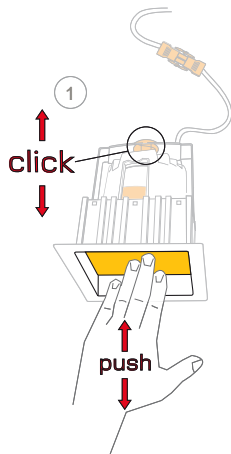

installation instructions / 150 plaster-in downlight:

- | | |
|----------------|----------------|
| P150RDL-LVC | P150SDL-LVC |
| P150RDL-CDM-TC | P150SDL-CDM-TC |
| P150RDL-CFL* | P150SDL-CFL* |
| P150RDL-LED-XI | P150SDL-LED-XI |
| P150RDL-LED-CL | P150SDL-LED-CL |

cut-out:
170mm x 170mm

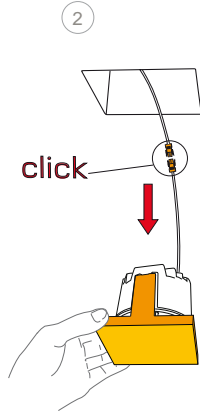
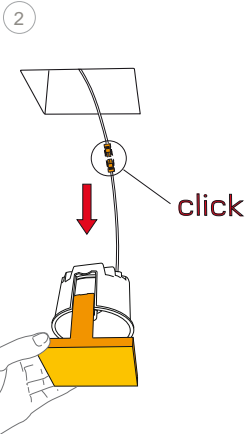
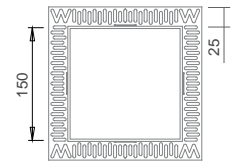
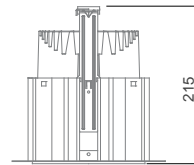

cut-out:
Ø 170mm

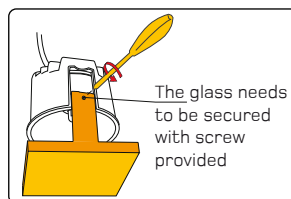
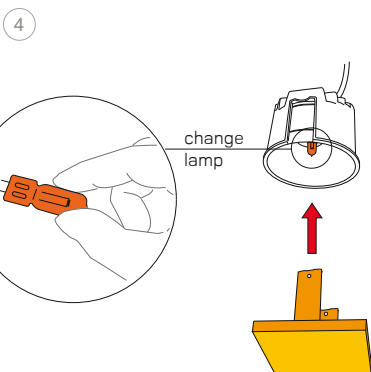
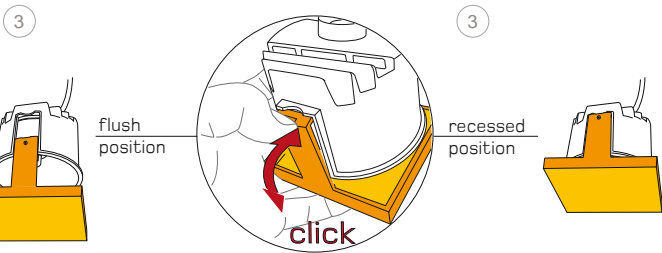
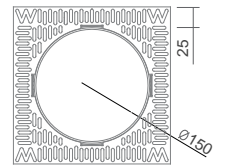
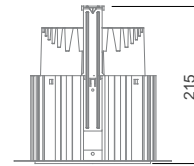

Registration number is WEE/FG0362QY

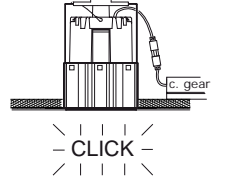
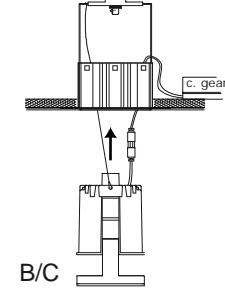
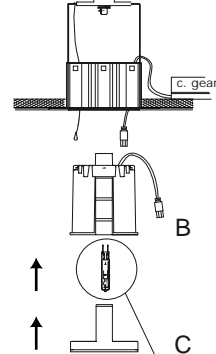
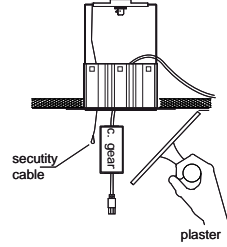
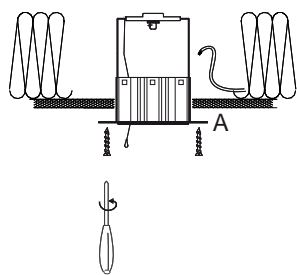
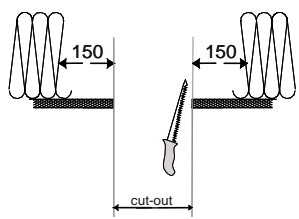

CFL



CDM-TC



LVC



LED

1 Ensure the housing is fixed securely in place

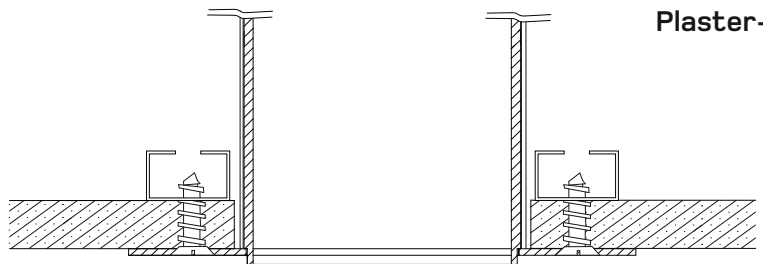

Plaster-in finish instructions

2 Distribute an even amount of plaster that conceals the trim of the housing.

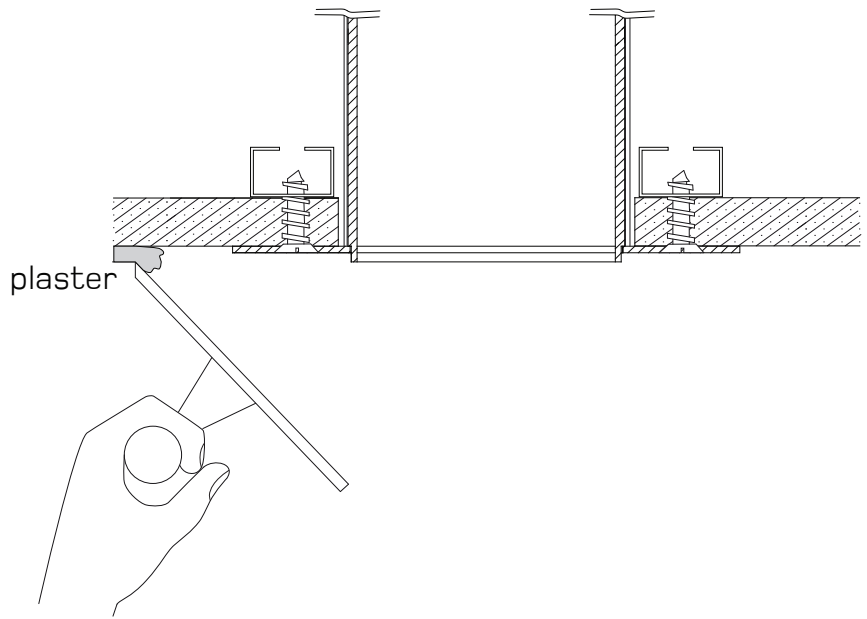

3 Ensure there is a smooth and neat finish at the edge of the housing. To achieve the correct result no plaster is to pass the housing lip

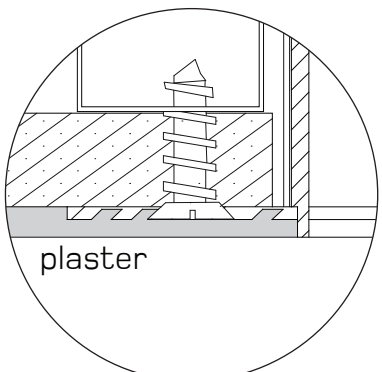
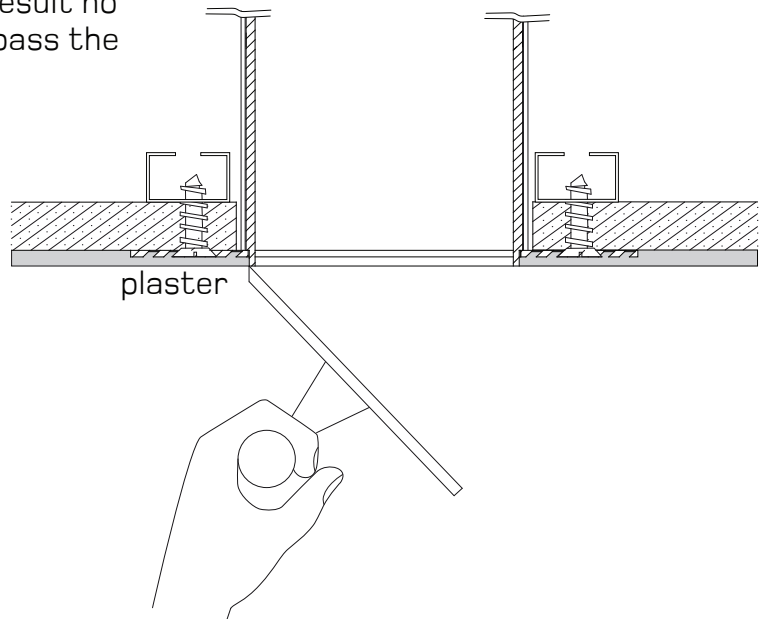

Correct finish

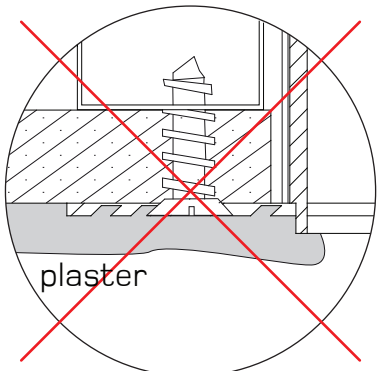

Incorrect finish

GB

Installation

Disconnect the mains supply before installation

This fixture is to be installed and maintained by a recognised electrician.

Care must be taken when plastering the housing that no excess plaster is applied on the inside of the luminaire housing as this is detrimental to the operation of the luminaire.

1. Cut-out the required recessing aperture and screw fix the frame (A) to the soffit (as shown). Use a timber batten backing to the soffit if stronger fixing points are required.
2. Remove any insulation or obstruction within 150mm of the mounting frame.
3. Plaster the ceiling using the lip of the frame as a stop bead for the plaster finish.
4. Clean any excess plaster from inside the mounting frame as this will have detrimental effect on the operation of the luminaire.

Make the electrical connection as follows:

Fitting Type: P150SDL-LVC; P150RDL-LVC; P150SDLRD-LVC; P150DLRD-LVC;

A. Remove the female 230/240v 50/60Hz 2-pin connector plug from the luminaire and wire the plug to the secondary side of the transformer. Refer to the transformer for a detailed wiring diagram. Use only Whitegoods supplied transformers.

B. Wire the mains input to the supplied transformer, refer to the transformer for a detailed wiring diagram.

C. Re-connect the female plug from the mains transformer to the male plug attached to the luminaire.

Fitting Type: P150SDL-MVC; P150RDL-MVC; P150SDLRD-MVC; P150DLRD-MVC

A. Unplug the female 230/240v 50/60Hz 3-pin connector from the lamp insert and wire the mains cable into position.

B. Re-connect the female to male plug.

Fitting Type: P150SDL-LED; P150RDL-LED; TBA.

Fitting Type: P150SDL-CDMTC; P150SDL-CDMTC;

A. Unplug the female 230/240v 50/60Hz 2-pin plug from the lamp insert and wire the control gear secondary side to the plug. Refer to the control gear for a detailed wiring diagram. Use only Whitegoods supplied control gear.

B. Wire the mains input to the supplied transformer, refer to the transformer for a detailed wiring diagram.

C. Re-connect the female plug from the mains transformer to the male plug attached to the luminaire.

Fitting Type: P150SDL-CFL; P150RDL-CFL;

A. Wire the mains input to the supplied control gear, refer to the control gear for a detailed wiring diagram.

B. Connect the cable plug from the control gear to the luminaire insert.

5. Insert the specific lamp into the lamp insert as shown overleaf.

6. Clip the glass stirrup (C) onto the lamp cartridge (B) (The glass stirrup can be connected in a the flush or recessed position, dependant on lamp type)

7. Connect the security cable to the luminaire insert and 'push-click' the lamp insert assembly (B/C) into the frame (A)

Re-lamping Procedure

Disconnect the mains power supply before re-lamping

1. 'Push-click' the lamp cartridge assembly (B/C) to release from the frame (A)

2. Suspend the assembly on the security cable wire

3. Remove the glass stirrup (C)

4. Replace the lamp within the lamp insert (B), (dispose of lamp according to specific regulations)

5. Re-fit the glass stirrup to lamp insert (The glass stirrup can be connected in a flush or recessed position as described above)

6. 'Push-click' the lamp insert assembly (B/C) into the frame (A)

FR

Installation

Débrancher la source principale d'alimentation avant de procéder à l'installation.

Cet accessoire doit être installé et entretenu par un électricien autorisé seulement.

Lors du plâtrage de la maison, veiller à ne pas appliquer trop de plâtre à l'intérieur du logement du luminaire, car cela pourrait compromettre le bon fonctionnement du luminaire.

1. Creuser l'ouverture de montage et fixer l'armature (A) au soffite par des vis comme indiqué. Appliquer une latte de bois au soffite si des points de fixation plus résistants se rendent nécessaires.
2. Enlever toute isolation ou obstruction dans les 150 mm autour de l'armature de montage.
3. Plâtrer le plafond en se servant du bec de l'armature comme point de référence pour la finition du plâtrage.
4. Enlever l'excès de plâtre de l'armature de montage, car cela pourrait compromettre le bon fonctionnement du luminaire.

Effectuer les connexions électriques comme suit :

Types de raccordement : P150SDL-LVC; P150RDL-LVC; P150SDLRD-LVC; P150DLRD-LVC;

A. Débrancher le connecteur femelle 230/240v 50/60 Hz à 2 broches du luminaire et connecter la prise au côté secondaire du transformateur. Consulter le schéma de câblage détaillé fourni avec le transformateur. N'utiliser que les transformateurs fournis par Whitegoods.

B. Connecter l'entrée principale au transformateur fourni. Consulter le schéma de câblage détaillé fourni avec le transformateur.

C. Rebrancher la prise femelle du transformateur principal à la prise mâle côté luminaire.

Types de raccordement : P150SDL-MVC; P150RDL-MVC; P150SDLRD-MVC; P150DLRD-MVC

A. Débranchez le connecteur femelle 230/240 v 50/60 Hz à 3 broches du porte-ampoule et connecter les câbles principaux en position.

B. Rebrancher la prise femelle à la prise mâle.

Types de raccordement : P150SDL-LED; P150RDL-LED; (EN PHASE CONCEPTUELLE)

Types de raccordement : P150SDL-CDMTC; P150SDL-CDMTC;

A. Débrancher la prise femelle 230/240 v 50/60 Hz à 2 broches du porte-ampoule et connecter la prise au côté secondaire de la commande de réglage à distance. Consulter le schéma de câblage détaillé fourni avec la commande de réglage à distance. N'utiliser que les commandes de réglage à distance fournies par Whitegoods.

B. Connecter l'entrée principale au transformateur fourni. Consulter le schéma de câblage détaillé fourni avec le transformateur.

C. Rebrancher la prise femelle du transformateur principal à la prise mâle côté luminaire.

Types de raccordement : P150SDL-CFL; P150RDL-CFL;

A. Connecter l'entrée principale à la commande de réglage à distance fournie. Consulter le schéma de câblage détaillé fourni avec la commande de réglage à distance.

B. Connecter la prise du câble de la commande de réglage à distance à l'armature.

5. Insérer l'ampoule dans son porte-ampoule comme indiqué.

6. Fixer l'étrier du diffuseur (C) sur le porte-ampoule (B). (L'étrier du diffuseur peut être inséré dans l'encastrement ou être enfoncé selon le type de lampe).

7. Connecter le fil de rétention à l'armature et ensuite bloquer le porte-ampoule (B/C) dans l'armature (A).

Remplacement de l'ampoule

Débrancher la source principale d'alimentation avant de remplacer l'ampoule.

1. Excercer une pression sur le porte-ampoule (B/C) pour le libérer de l'armature (A).

2. Suspender l'ensemble par le fil de sécurité.

3. Enlever l'étrier du diffuseur (C)

4. Remplacer l'ampoule qui se trouve dans le porte-ampoule (B). Eliminer l'ampoule conformément aux normes en vigueur dans ce domaine.

5. Repositionner l'étrier du diffuseur sur le porte-ampoule. (L'étrier du diffuseur peut être inséré dans l'encastrement ou être enfoncé comme indiqué ci-dessus).

6. Excercer une pression sur le porte-ampoule (B/C) pour qu'il se bloque dans l'armature (A).

SP

Instalación

Desconecte la alimentación eléctrica antes de llevar a cabo la instalación.

Esta luminaria debe ser instalada y mantenida por un electricista autorizado.

Prestar atención al colocar el emplaste en la caja, tratando de que el exceso de emplaste no entre en el interior de la caja de la luminaria; esto es perjudicial para el funcionamiento de la luminaria.

1. Corte la abertura necesaria para empotrar la luminaria y fije el bastidor (A) al falso techo (como se muestra). Si se requiere una fijación más segura utilice un listón de madera para reforzar el falso techo.

2. Retire el material aislante o cualquier otro obstáculo que se encuentre a una distancia de 150 mm del bastidor.

3. Coloque emplaste al cieloraso según se necesite usando el reborde del bastidor como tope para el acabado de emplaste.

4. Limpie el exceso de emplaste desde el interior del bastidor para evitar efectos perjudiciales en el funcionamiento de la luminaria.

Haga las conexiones eléctricas como se indica a continuación:

Acoplamiento de tipo: P150SDL-LVC; P150RDL-LVC; P150SDLRD-LVC; P150DLRD-LVC;

A. Desenchufe el conector hembra de dos patillas 230/240v 50/60Hz, de la luminaria y empalme el toma al lado secundario del transformador. Vease el transformador para un diagrama detallado del cableado. Utilice sólo los transformadores Whitegoods suministrados.

B. Empalme la entrada de corriente al transformador suministrado, vease el transformador para un diagrama detallado del cableado.

C. Vuelva a conectar el toma hembra desde la alimentación del transformador al toma macho unido a la luminaria.

Acoplamiento de tipo: P150SDL-MVC; P150RDL-MVC; P150SDLRD-MVC; P150DLRD-MVC

A. Desenchufe el conector hembra de tres patillas, 230/240v 50/60Hz, del casquillo de la bombilla y conecte en su posición el cable de entrada de corriente.

B. Vuelva a conectar el conector hembra al toma macho

Acoplamiento de tipo: P150SDL-LED; P150RDL-LED; TBA.

Acoplamiento de tipo: P150SDL-CDMTC; P150SDL-CDMTC;

A. Desenchufe el conector hembra de 2 patillas, 230/240v 50/60Hz, del casquillo de la bombilla y conecte el lado secundario del aparellaje al toma. Vease el aparellaje para un diagrama detallado del cableado. Utilice sólo aparellajes suministrados por Whitegoods.

B. Empalme la entrada de corriente al transformador suministrado, vease el transformador para un diagrama detallado del cableado.

C. Vuelva a conectar el toma hembra desde la alimentación del transformador al toma macho unido a la luminaria.

Acoplamiento de tipo: P150SDL-CFL; P150RDL-CFL;

A. Empalme la entrada de corriente al transformador suministrado, vease el

apparellaje para un diagrama detallado del cableado.

B. Conecte el enchufe desde el aparellaje al encastre de la luminaria.

5. Coloque la bombilla específica en el casquillo de la bombilla como se muestra al dorso.

6. Enganche el estribo de vidrio (C) al casquillo de la bombilla (B) (El estribo de vidrio se puede acoplar en la posición enrasada o emprotrada, dependiendo del tipo de bombilla).

7. Conecte el cable de seguridad al a alimentación al casquillo de la luminaria y presione el conjunto de casquillo (B/C) en el bastidor (A).

Cambio de la bombilla

Antes de cambiar la bombilla desconecte la alimentación eléctrica.

1. Presione el conjunto del casquillo (B/C) para desencajarlo del bastidor (A).

ITA

Installazione

Prima dell'installazione staccare le corrente.

L'installazione e qualsiasi intervento deve essere effettuato da un elettricista autorizzato.

Fare attenzione che al momento della posa dell'intonaco parte di questo non finisca all'interno del sistema di illuminazione.

1. Ritagliare un'apertura e fissare il telaio (A) con delle viti al soffitto (come mostrato). Utilizzare un rinforzo in legno qualora siano necessari dei punti di fissaggio piu' solidi.

2. Rimuovere il materiale isolante o eventuali altri ostacoli nel raggio di 150mm dal telaio.

3. Intonacare il soffitto fino a bordo del telaio

4. Rimuovere l'eccesso di intonaco all'interno del telaio che altrimenti comprometterebbe un regolare funzionamento del sistema di illuminazione.

Effettuare il collegamento elettrico come segue

Per i modelli: P150SDL-LVC; P150RDL-LVC; P150SDLRD-LVC; P150RDLRD-LVC;

A. Scollegare la presa femmina a due spinotti 230/240v 50/60Hz dal portalampada e collegare la presa al trasformatore.

B. Collegare la corrente principale al trasformatore. Per un diagramma di cablaggio piu' dettagliato fare riferimento alle indicazioni sul trasformatore. Utilizzare solo i trasformatori forniti da Whitegoods.

C. Riconnettere le presa della lampada alla presa del trasformatore.

Per i modelli: P150SDL-MVC; P150RDL-MVC; P150SDLRD-MVC; P150RDLRD-MVC

A. Scollegare la presa femmina a tre spinotti 230/240v 50/60Hz dal portalampada e collegare il cavo principale nella sua posizione.

B. Riconnettere le prese maschio e femmina tra di loro.

Per i modelli: P150SDL-LED; P150RDL-LED; (in fase di progettazione)

Per i modelli: P150SDL-CDMTC; P150SDL-CDMTC;

A. Scollegare la presa femmina a due spinotti 230/240v 50/60Hz dal portalampada e collegare la presa al trasformatore.

B. Collegare la corrente principale al trasformatore. Per un diagramma di cablaggio piu' dettagliato fare riferimento alle indicazioni sul trasformatore. Utilizzare solo i trasformatori forniti da Whitegoods

Per i modelli: P150SDL-CFL; P150RDL-CFL;

A. Collegare la corrente principale al trasformatore. Per un diagramma di cablaggio piu' dettagliato fare riferimento alle indicazioni sul trasformatore. Per un diagramma di cablaggio piu' dettagliato fare riferimento alle indicazioni sul trasformatore.

B. Collegare il trasformatore al portalampada.

5. Inserire la lampadina adeguata all'interno del portalampada (B) (come mostrato in figura).

6. Incastrare la montatura del vetro (C) nell'apposito binario del portalampada (B) come mostrato in figura (puo' essere montato a filo del soffitto o in posizione rientrante in dipendenza anche del tipo di lampada)

7. Connettere il cavo di sicurezza al portalampada e spingere ("push-click") le parti assemblate (B/C) all'interno del telaio (A).

Sostituzione della lampadina

Staccare la corrente prima di sostituire la lampadina.

1. Spingere ("push-click") il portalampada assemblato (B/C) perche' venga rilasciato dal telaio (A).

2. Lascire pendere il portalampada utilizzando la corda di sicurezza.

3. Rimuovere la montatura del vetro (C) dall'incastro.

4. Sostituire la lampadina all'interno del portalampada (B)(utilizzare a norma con il sistema di illuminazione)

5. Incastrare la montatura del vetro (C) nell'apposito binario del portalampada come mostrato in figura (puo' essere montato a filo del soffitto o in posizione rientrante in dipendenza anche del tipo di lampada)

6. Connettere il cavo di sicurezza al portalampada e spingere ("push-click") le parti assemblate (B/C) all'interno del telaio (A).

Lamp Removal (Flush Fit Diffuser)

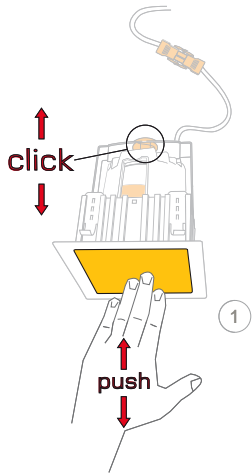

Lamp Removal (Flush Fit Diffuser)

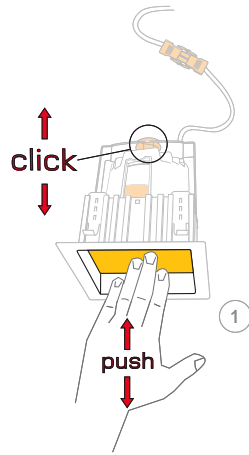

installation instructions / 150 bezel downlight:

B150RDL-LVC	B150SDL-LVC
B150RDL-CDM-TC	B150SDL-CDM-TC
B150RDL-CFL*	B150SDL-CFL*
B150RDL-LED-XI	B150SDL-LED-XI
B150RDL-LED-CL	B150SDL-LED-CL

cut-out:
170 x 170mm

***flush fit diffuser only**

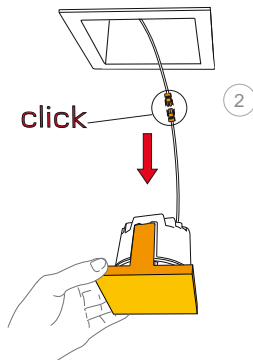
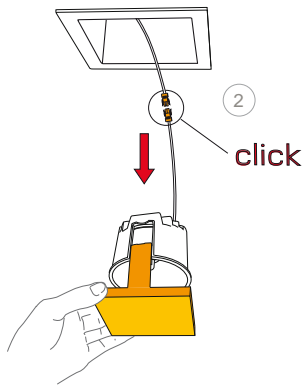
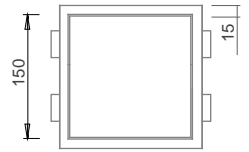
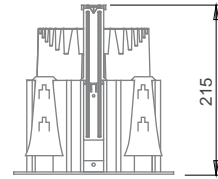

cut-out:
Ø170mm

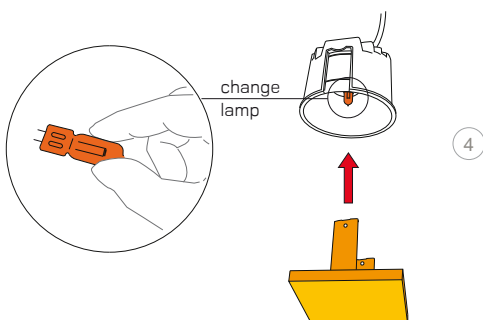
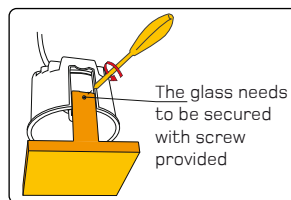
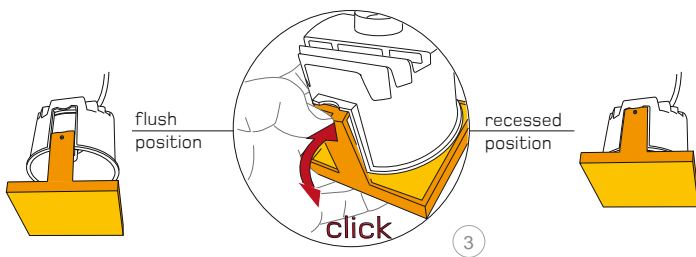
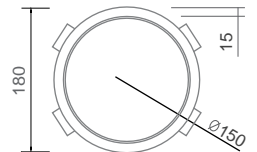
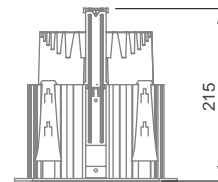

Registration number is WEE/FG0362QY

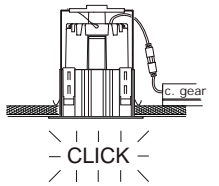
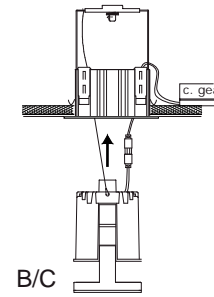
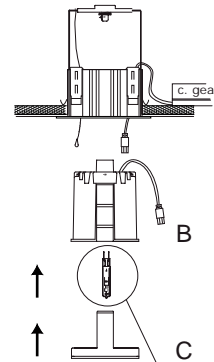
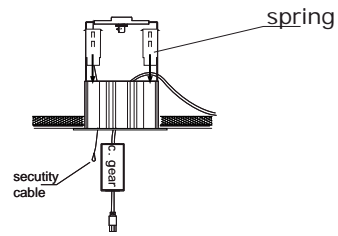
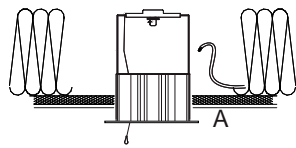
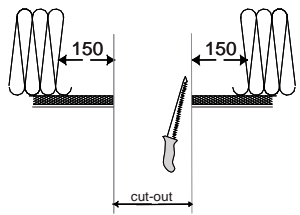
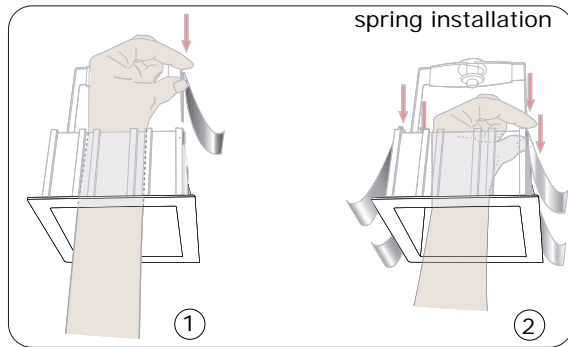

CFL



CDM-TC



LVC



LED

GB**Installation**

Disconnect the mains supply before installation.

This fixture is to be installed and maintained by a recognized electrician.

1. Cut-out the required mounting aperture and install the frame (A) to the soffit as shown. Make sure the spring clips are fixed securely against the soffit (use a timber backing for extra support if required).

2. Remove any insulation or obstruction within 150mm of the aperture.

Make the electrical connection as follows:

Fitting Type: B150SDL-LVC; B150RDL-LVC; B150SDLRD-LVC; B150RDLRD-LVC;

A. Remove the female 230/240v 50/60Hz 2-pin connector plug from the luminaire and wire the plug to the transformer. Refer to the transformer for a detailed wiring diagram. Use only Whitegoods supplied transformers.

B. Wire the mains input to the supplied transformer, refer to the transformer for a detailed wiring diagram.

C. Re-connect the female plug from the mains transformer to the male plug attached to the luminaire.

Fitting Type: B150SDL-MVC; B150RDL-MVC; B150SDLRD-MVC; B150RDLRD-MVC

A. Unplug the female 230/240v 50/60Hz 3-pin connector from the lamp insert and wire the mains cable into position.

B. Re-connect the female to male plug.

Fitting Type: B150SDL-LED; B150RDL-LED; TBA

Fitting Type: B150SDL-CDMTC; B150SDL-CDMTC;

A. Unplug the female 230/240v 50/60Hz 2-pin plug from the lamp insert and wire the control gear secondary side to the plug. Refer to the control gear for a detailed wiring diagram. Use only Whitegoods supplied control gear.

B. Wire the mains input to the supplied transformer, refer to the transformer for a detailed wiring diagram.

C. Re-connect the female plug from the mains transformer to the male plug attached to the luminaire.

Fitting Type B150SDL-CFL; B150RDL-CFL;

A. Wire the mains input to the supplied control gear, refer to the control gear for a detailed wiring diagram.

B. Connect the cable plug from the control gear to the luminaire insert.

3. Insert the specific lamp into the lamp insert as shown.

4. Connect the mains power supply to the primary input on the supplied control gear. Refer to the control gear for a detailed wiring diagram

5. Clip the glass stirrup (C) onto the lamp cartridge (B) (The glass stirrup can be connected in a the flush or recessed position, dependant on lamp type, see overleaf)

6. Connect the retaining cord to the luminaire insert and 'push-click' the lamp insert assembly (B/C) into the frame (A)

Re-lamping Procedure

Disconnect the mains power supply before re-lamping

1. 'Push-click' the lamp cartridge assembly (B/C) to release from the

frame (A)

2. Suspend the assembly on the retention wire

3. Remove the glass stirrup (C)

4. Replace the lamp within the lamp insert (B), (dispose of lamp according to specific regulations)

5. Re-fit the glass stirrup to lamp insert (The glass stirrup can be connected in a flush or recessed position as described above)

6. 'Push-click' the lamp insert assembly (B/C) into the frame (A)

FR**Installation**

Débrancher la source principale d'alimentation avant de procéder à l'installation.

Cet accessoire doit être installé et entretenu par un électricien autorisé seulement.

1. Creuser une ouverture de montage et monter l'armature (A) sur le soffite comme indiqué. S'assurer que les brides de ressort adhèrent parfaitement à la surface du soffite. (Utiliser une latte de bois si un support plus résistant se rend nécessaire).

2. Enlever toute isolation ou obstruction dans 150 mm de l'ouverture.

Effectuer les connexions électriques comme suit :

Types de raccordement : B150SDL-LVC; B150RDL-LVC; B150SDLRD-LVC; B150RDLRD-LVC;

A. Débrancher le connecteur femelle 230/240v 50/60 Hz à 2 broches du luminaire et connecter la prise au transformateur. Consulter le schéma de câblage détaillé fourni avec le transformateur. N'utiliser que les transformateurs fournis par Whitegoods.

B. Connecter l'entrée principale au transformateur fourni. Consulter le schéma de câblage détaillé fourni avec le transformateur.

C. Rebrancher la prise femelle du tranformateur principal à la prise mâle côté luminaire—.

Types de raccordement : B150SDL-MVC; B150RDL-MVC; B150SDLRD-MVC; B150RDLRD-MVC

A. Débranchez le connecteur femelle 230/240 v 50/60 Hz à 3 broches du porte-ampoule et connecter les câbles principaux en position.

B. Rebrancher la prise femelle à la prise mâle.

Types de raccordement : B150SDL-LED; B150RDL-LED; (EN PHASE CONCEPTUELLE)

Types de raccordement : B150SDL-CDMTC; B150SDL-CDMTC;

A. Débrancher la prise femelle 230/240 v 50/60 Hz à 2 broches du porte-ampoule et connecter la prise au côté secondaire de la commande de réglage à distance. Consulter le schéma de câblage détaillé fourni avec la commande de réglage à distance. N'utiliser que les commandes de réglage à distance fournies par Whitegoods.

B. Connecter l'entrée principale au transformateur fourni. Consulter le schéma de câblage détaillé fourni avec le transformateur.

C. Rebrancher la prise femelle du tranformateur principal à la prise mâle côté luminaire.

Types de raccordement : B150SDL-CFL; B150RDL-CFL;

A. Connecter l'entrée principale à la commande de réglage à distance fournie. Consulter le schéma de câblage détaillé fourni avec la commande de réglage à distance.

B. Connecter la prise du câble de la commande de réglage à distance à l'armature du luminaire.

3. Insérer la lampe dans son porte-ampoule comme indiqué.

4. Connecter la source principale d'alimentation à l'entrée primaire sur la commande de réglage à distance. Consulter le schéma de câblage détaillé fourni avec la commande de réglage à distance.

5. Fixer l'étrier du diffuseur (C) sur le porte-ampoule (B). (L'étrier du diffuseur peut être inséré dans l'encastrement ou être enfoncé selon le type de lampe, consulter le verso).

6. Connecter le fil de rétention à l'armature du luminaire et ensuite bloquer le porte-ampoule (B/C) dans l'armature (A).

Remplacement de l'ampoule:

Débrancher la source principale d'alimentation avant de remplacer l'ampoule.

1. Exercer une pression sur le porte-ampoule (B/C) pour le libérer de l'armature (A).

2. Suspendre l'ensemble par le fil de rétention.

3. Enlever l'étrier du diffuseur (C)

4. Remplacer l'ampoule qui se trouve dans le porte-ampoule (B). Eliminer l'ampoule conformément aux normes en vigueur dans ce domaine.

5. Repositionner l'étrier du diffuseur sur le porte-ampoule. (L'étrier du diffuseur peut être inséré dans l'encastrement ou être enfoncé comme indiqué ci-dessus).

6. Exercer une pression sur le porte-ampoule (B/C) pour qu'il se bloque dans l'armature (A).

SP**Instalación**

Desconecte la alimentación eléctrica antes de llevar a cabo la instalación.

Esta luminaria debe ser instalada y mantenida por un electricista autorizado.

1. Corte la abertura necesaria para empotrar la luminaria y fije el bastidor (A) al falso techo como se muestra. Compruebe que las pinzas de sujeción queden firmemente ancladas a la parte interior del falso techo (si se requiere una fijación más segura utilice un listón de madera para reforzar el falso techo).

2. Retire el material aislante o cualquier otro obstáculo que se encuentre a una distancia de 150 Mm. de la apertura.

Haga las conexiones eléctricas como se indica a continuación: Acoplamiento de tipo: B150SDL-LVC; B150RDL-LVC; B150SDLRD-LVC; B150RDLRD-LVC;

A. Desenchufe el conector hembra 230/240v 50/60Hz, de la luminaria y



empalme el conector al transformador. Véase el transformador para un diagrama detallado del cableado. Utilice sólo los transformadores Whitegoods suministrados.

B. Conecte la entrada de corriente al transformador suministrado, véase el transformador para un diagrama detallado del cableado.

C. Vuelva a conectar el conector hembra desde la alimentación del transformador al conector macho unido a la luminaria.

Acoplamiento de tipo: B150SDL-MVC; B150RDL-MVC; B150SDLRD-MVC; B150RDLRD-MVC

A. Desenchufe el conector hembra de tres patillas, 230/240v 50/60Hz, del casquillo de la bombilla y conecte en su posición el cable de entrada de corriente.

B. Vuelva a conectar el conector hembra al conector macho

Acoplamiento de tipo: B150SDL-LED; B150RDL-LED; TBA

Acoplamiento de tipo: B150SDL-CDMTC; B150RDL-CDMTC;

A. Desenchufe el conector hembra de 2 patillas, 230/240v 50/60Hz, del casquillo de la bombilla y conecte el lado secundario del aparellaje al conector. Véase el aparellaje para un diagrama detallado del cableado. Utilice sólo aparellajes suministrados por Whitegoods.

B. Conecte la entrada de corriente al transformador suministrado, véase el transformador para un diagrama detallado del cableado.

C. Vuelva a conectar el conector hembra desde la alimentación del transformador al conector macho unido a la luminaria.

Acoplamiento de tipo: B150SDL-CFL; B150RDL-CFL;

A. Conecte la entrada de corriente al transformador suministrado, véase el aparellaje para un diagrama detallado del cableado.

B. Conecte el enchufe desde el aparellaje al encastre de la luminaria.

3. Coloque la bombilla específica en el encastre de la bombilla como se muestra.

4. Conecte la alimentación eléctrica a la entrada primaria del aparellaje provisto. Véase el aparellaje para un diagrama detallado del cableado.

5. Enganche el estribo de vidrio (C) al casquillo de la bombilla (B) (El estribo de vidrio se puede acoplar en la posición enrasada o empotrada, dependiendo del tipo de bombilla, ver al dorso).

6. Conecte la alimentación al casquillo y al cable de retención y presione el conjunto de casquillo (B/C) en el bastidor (A).

Cambio de la bombilla

Antes de cambiar la bombilla desconecte la alimentación eléctrica.

1. Presione el conjunto del casquillo (B/C) para desengancharlo del bastidor (A).

2. Deje el conjunto colgando del cable de retención.

3. Retire el estribo de vidrio (C).

4. Cambie la bombilla dentro del casquillo (B), (deshágase de la bombilla según las normas específicas).

5. Vuelva a acoplar el estribo de vidrio al casquillo. (El estribo de vidrio se puede acoplar en la posición rasada o empotrada).

6. Presione el conjunto del casquillo (B/C) en el bastidor (A).

Installazione

Prima dell'installazione staccare le corrente.

L'installazione e qualsiasi intervento deve essere effettuato da un elettricista autorizzato.

1. Ritagliare un'apertura e fissare il telaio (A) al soffitto come mostrato. Fare attenzione che le molle facciano buona presa contro il soffitto. Utilizzare un rinforzo in legno qualora siano necessari dei punti di fissaggio piu' solidi.

2. Rimuovere il materiale isolante o eventuali altri ostacoli nel raggio di 150mm dal telaio.

Effettuare il collegamento elettrico come segue

Per i modelli: B150SDL-LVC; B150RDL-LVC; B150SDLRD-LVC; B150RDLRD-LVC;

A. Scollegare le presa femmina a due spinotti 230/240v 50/60Hz dal portalampada e collegare la presa al trasformatore.

B. Collegare la corrente principale al trasformatore. Per un diagramma di cablaggio piu' dettagliato fare riferimento alle indicazioni sul trasformatore. Utilizzare solo i trasformatori forniti da Whitegoods.

C. Riconnettere le prese maschio del trasformatore con la presa femmina del portalampada.

Per i modelli: B150SDL-MVC; P150RDL-MVC; B150SDLRD-MVC; B150RDLRD-MVC

A. Scollegare la presa femmina a tre spinotti 230/240v 50/60Hz dal portalampada e collegare il cavo principale nella sua posizione.

B. Riconnettere le prese maschio del trasformatore con la presa femmina del portalampada.

Per i modelli: B150SDL-LED; P150RDL-LED; (in fase di progettazione)

Per i modelli: B150SDL-CDMTC; B150RDL-CDMTC;

A. Scollegare le presa femmina a due spinotti 230/240v 50/60Hz dal portalampada e collegare la presa al trasformatore.

B. Collegare la corrente principale al trasformatore. Per un diagramma di cablaggio piu' dettagliato fare riferimento alle indicazioni sul trasformatore. Utilizzare solo i trasformatori forniti da Whitegoods.

Per i modelli: B150SDL-CFL; B150RDL-CFL;

A. Collegare la corrente principale al trasformatore. Per un diagramma di cablaggio piu' dettagliato fare riferimento alle indicazioni sul trasformatore. Per un diagramma di cablaggio piu' dettagliato fare riferimento alle indicazioni sul trasformatore.

B. Collegare il trasformatore al portalampada.

3. Inserire la lampadina adeguata all'interno del portalampada (B) (come mostrato in figura).

4. Incastrare la montatura del vetro (C) nell'apposito binario del portalampada (B) come mostrato in figura (puo' essere montato a filo del soffitto o in posizione rientrante in dipendenza anche del tipo di lampada)

5. Connettere il cavo di sicurezza al portalampada e spingere ("push-click") le parti assemblate (B/C) all'interno del telaio (A).

Sostituzione della lampadina

Staccare la corrente prima di sostituire la lampadina.

1. Spingere ("push-click") il portalampada assemblato (B/C) perche' venga rilasciato dal telaio (A).

2. Lasciare pendere il portalampada utilizzando la corda di sicurezza.

3. Rimuovere la montatura del vetro (C) dall'incastro.

4. Sostituire la lampadina all'interno del portalampada (B)(utilizzare a norma con il sistema di illuminazione)

5. Incastrare la montatura del vetro (C) nell'apposito binario del portalampada come mostrato in figura (puo' essere montato a filo del soffitto o in posizione rientrante in dipendenza anche del tipo di lampada)

6. Connettere il cavo di sicurezza al portalampada e spingere ("push-click") le parti assemblate (B/C) all'interno del telaio (A)

Installation The installation of these products should only be carried out by a suitably qualified electrician in accordance with the instructions supplied with the product. All installation instructions can be downloaded from our website. We recommend that they are included with construction issue drawings and specifications.

Ceiling void depths for recessed downlights and linear luminaires: The Ceiling void depth should ideally be 25mm deeper than the overall height of the luminaire. When a fire-hood and/or a remote emergency pack is to be used, the void depth and space surrounding the luminaire will need to be increased.

Dimensions and specification The drawings, dimensions and finishes of the products in this catalogue and any accompanying information are purely indicative. Great care is taken to provide up to date information in this publication, however, due to a continuing programme of design and development, we reserve the right to change these dimensions without prior notice. Please check the website for most up to date information. If a dimension is critical to the success of your project, please confirm it directly with the technical department. Throughout this publication, cut-out sizes refer to the aperture required when fittings are mounted in soft plasterboard. For fibrous tiles, timber, metal tiles and cast-in construction, check dimensions on site, or ask for a sample. Whitegoods reserves the right to discontinue any product in this publication at any time without prior notice.

Performance All photometric data supplied is taken from a standard production luminaire tested under ideal laboratory conditions and may vary from data taken in alternative conditions. All calculated light levels and/or lighting plots provided are offered for guidance only. The customer must satisfy themselves that luminaires proposed are suitable for the application intended in all performance and physical criteria.

Temperature and physical environment All products are tested with stated lamp wattage. Incorrect lamp types and wattages may effect efficiency, create glare and seriously overheat the luminaire. Adequate ventilation and free air space around fittings (in accordance with the installation instructions supplied with the product) will be necessary when used in confined spaces where elevated temperatures will occur. All luminaires are designed to operate in a maximum 30degree ambient temperature. Operating in ambient temperatures above this can affect performance and the mechanical functionality of the luminaire.

Intellectual property In order that we can continue to develop innovative quality products, we believe it is of critical importance that we protect our ideas and visions. Therefore any infringement of our intellectual property will be vigorously pursued.

Returns We cannot offer refunds on Custom or Tailored products, Standard product may be eligible for re-stocking within 3 months of original purchase date, subject to a 30% handling charge. All original packaging and documentation must be present and goods must be in original condition.

Service Whitegoods will endeavor to fulfill all orders as quickly as possible and treat all customers with the highest regard. For further information about Whitegoods products and services, please visit www.whitegoods.com.

WEEE directive The Waste Electrical and Electronic Equipment Directive (WEEE Directive) is the European Community directive 2002/96/EC on waste electrical and electronic equipment, together with the RoHS Directive 2002/95/EC which became European Law in February 2003, setting collection, recycling and recovery targets for all types of electrical goods. This imposes responsibility for the disposal of waste electrical and electronic equipment (WEEE) on the manufacturers of such equipment. To meet these targets Whitegoods has become a member of Lumicom to allow us to meet the current and future directives. For further information on the WEEE directive please contact our offices. WEEE Registration number is WEE/FG0362QY

