

60 square plaster-in downlight

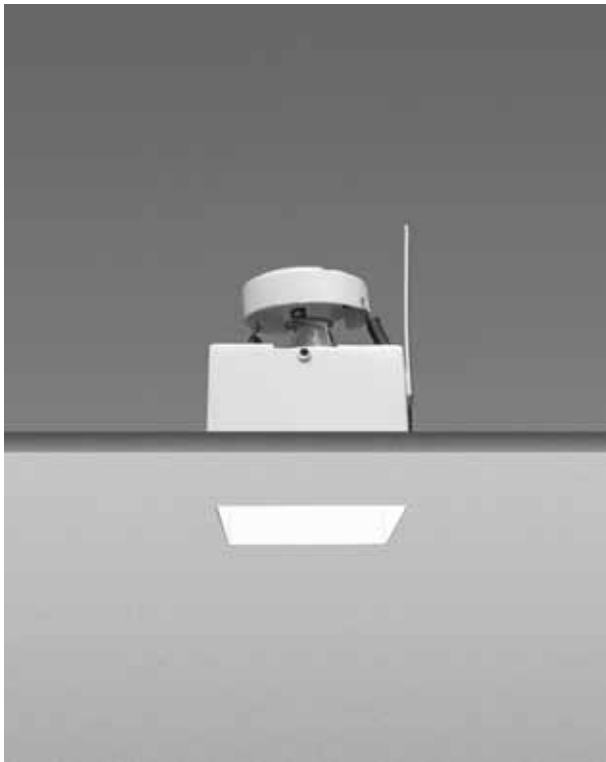







A 60mm square recessed luminaire with absolute minimal visual impact.

Applications:

- Where the ceiling is to be plastered or re-plastered with a gypsum finish.

Features:

- Bayonet tool free second fix internal cartridge.
- Tool free lamp maintenance.
- Frosted glass lens, coloured dichroic glass filter and louvre system available.
- Available as IP 65 version (all lamps types).
- Recessed lamp position for low glare.
- Gear/ transformer sized to fit through aperture if supplied by Whitegoods.

code	lamp	type	base	(1) watts	(1) cd / lumen	cut-out
P60SDL-LVR	 Low voltage reflector lamp	MR16	GU5.3	20-50W	1000-2850 cd	70 x 70 mm
P60SDL-LEDR-GU10	 LED reflector lamp	MR16	GU10	-	-	70 x 70 mm
P60SDL-LEDR-GU5.3	 LED reflector lamp	MR16	GU5.3	-	-	70 x 70 mm
P60SDL-MVR	 Mains voltage reflector lamp	MR16	GU10	max 50W	350-1000 cd [25°]	70 x 70 mm
P60SDL-CDMR	 Ceramic metal halide reflector	MR16	GX10	20-35W	3900-18000 cd	70 x 70 mm
P60SDL-LED-XI-830-700	 Xicato XSM-700	Xicato	-	5 - 8W	500lm	70 x 70 mm

IP 65 version

P60SDLIP-lamp type (example - P60SDLIP-LEDR-GU5.3)	(as above)	70 x 70 mm
--	------------	------------

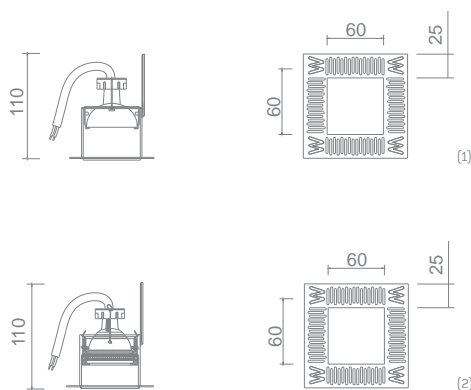

Notes:

1. Standard fitting
 2. IP 65 rated fitting
 3. Indicative lamp information shown. Consult lamp manufacturer for current information.
- Lamp is recessed 30mm back from the ceiling
 - Plug is not supplied
 - LED specification subject to change. Please contact us for latest info.
 - Recess depth required is 110mm for LVR & MVR lamps, 170mm for CMH lamps, Xicato and emergency.

Other information:

IP Rating	Page 152
Important information	Page 181
Dimming	Page 182
Accessories	Page 185