

150 linear bezel luminaire

A 150mm linear recessed luminaire with minimal visual impact.

Applications:







- Where the ceiling is not able to accept a plaster finish.

Features:

- Twin lamp configuration.
- Twin overlapping lamp configuration on four lamp units.
- Single tool second fix internal lamp cartridge.
- Tool free lamp and gear maintenance.
- Internal cartridges with pre-wired plug connectors for efficient installation.

Ballast options:

- Switched
- Analogue (1-10v)
- Digital (DSI)
- DALI

code		lamp	type	base	watts	lumen	cut-out
B150LDL6-214		T5 fluorescent	T5	G5	2 x 14W	2400 lm	620 x 170 mm
B150LDL9-221		T5 fluorescent	T5	G5	2 x 21W	3800 lm	920 x 170 mm
B150LDL12-228		T5 fluorescent	T5	G5	2 x 28W	5200 lm	1220 x 170 mm
B150LDL15-235		T5 fluorescent	T5	G5	2 x 35W	6600 lm	1520 x 170 mm
B150LDL18-421		T5 fluorescent	T5	G5	4 x 21W	7600 lm	1820 x 170 mm
B150LDL24-428		T5 fluorescent	T5	G5	4 x 28W	10400 lm	2420 x 170 mm
B150LDL30-435		T5 fluorescent	T5	G5	4 x 35W	13200 lm	3020 x 170 mm

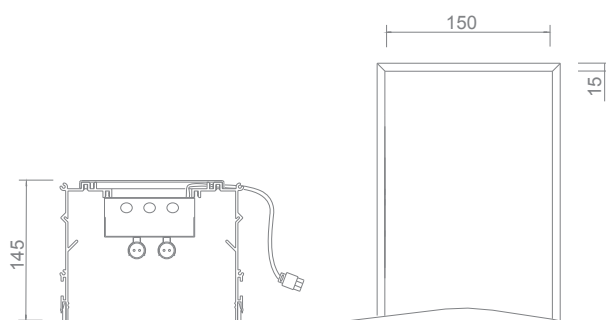

Notes:

- Continuous linear available. Please refer to page 119.
- Available for use with rod or optional cable installation methods. Please specify when ordered. Please allow 50mm minimum above luminaire for installation of suspension system.
- The bezel trim has a mitre joint at each corner.

Other information:

Important information	Page 181
Dimming	Page 182
Emergency Lighting	Page 184
Accessories	Page 185